

Article number: 03504250

Description: Fluro Rod end GE 250LO

Measures

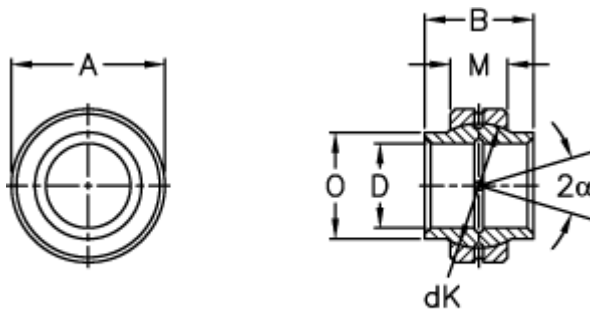

Str. 12 den smørerille

A	= 400 0 -0,040	Tilt angle = 4
B	= 250	Weight = 102000
D	= 250 0 +0,046	
dK	= 350	
Dynamic load C (kN)	= 3550	
M	= 120	
O	= 317	
Static load C0 (kN)	= 18000	